



**NONLINEARLABS**

**QUICK  
START**

**C15**



**Quickstart Manual**

# Precautions

## Power Supply

Please use only the included power adapter. If this is not possible, obtain a power adapter with the following specifications:

- 18 – 20 V DC
- 2.5 A or higher
- Plug: inner contact 2.5 mm (+)
- Plug outer contact 5.5 mm (–)



Do not use a power adapter with different or unknown specifications, as this may electrically damage the device! You use a non-original power adapter at your own risk. Nonlinear Labs is not liable for damage caused by use of non-original power adapters.



## Things to avoid doing

Do not place the C15 on a soft surface (pillow, mattress, etc.) as this can block the circulation of air to the device while it is being used.

The C15 is an electrical (and electronic) device: do not allow water to come into contact with it.

Do not open the C15. The inner parts of the instrument compose an intricate network which is easily damaged and potentially hazardous for inexperienced users.

Do not use the C15 in extreme ambient temperatures. Stable performance cannot be guaranteed in very hot or cold conditions. Also avoid high humidity and other difficult conditions.

Always wait for the device to shut down completely before you disconnect its power supply. Do not disconnect the power supply during performance. Doing so can cause data to be lost.

## Package Contents

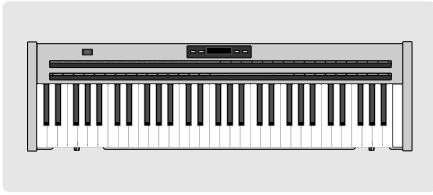

C15 Base Unit

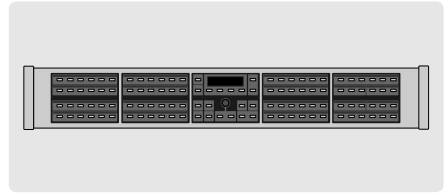

C15 Panel Unit

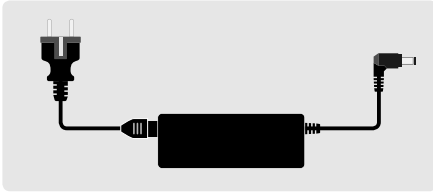

Power Supply adapter and cable

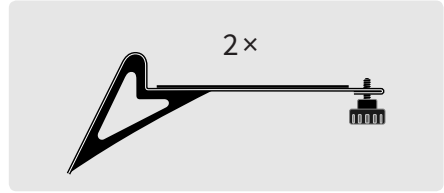

2 Mounting Brackets with Mounting Screws



Printed C15 Quickstart Manual

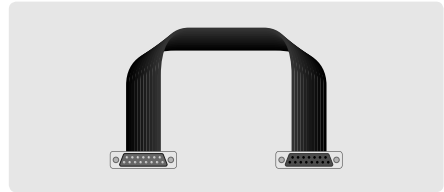

Unit Connector Cable



USB Flash Drive containing:

- the Factory Preset Collection
- the complete C15 User Reference

**!** The flash drive is specially formatted for installing updates. Do not format it and keep it safe!

# Device Overview

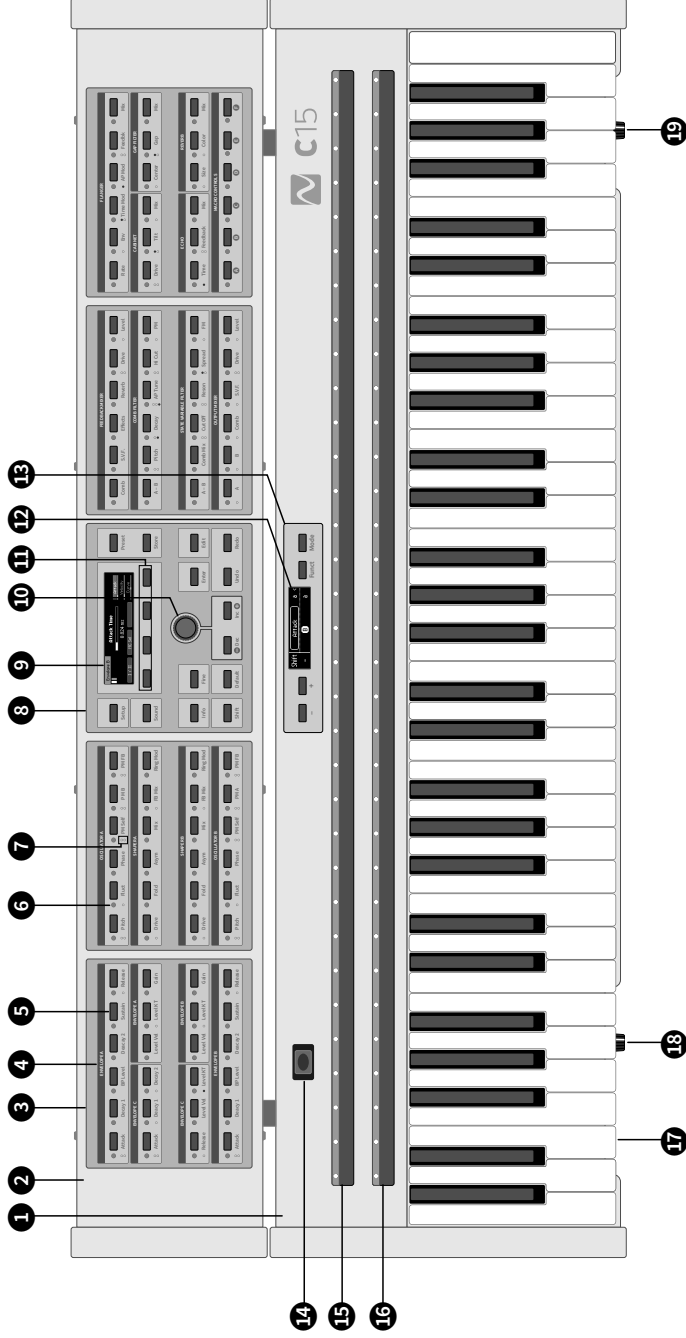

- |                                     |  |                                   |                                |
|-------------------------------------|--|-----------------------------------|--------------------------------|
| <b>1</b> Base Unit                  | <b>6</b> Parameter Selection Indicator | <b>11</b> Soft Buttons            | <b>16</b> Ribbon 2             |
| <b>2</b> Panel Unit                 | <b>7</b> Multiple Parameter Indicator  | <b>12</b> Base Unit Display       | <b>17</b> Headphones Connector |
| <b>3</b> Parameter Panel            | <b>8</b> Edit Panel                    | <b>13</b> Base Unit Control Panel | <b>18</b> Headphones Volume    |
| <b>4</b> Parameter Group            | <b>9</b> Panel Unit Display            | <b>14</b> Bender                  | <b>19</b> Output Volume        |
| <b>5</b> Parameter Selection Button | <b>10</b> Encoder                      | <b>15</b> Ribbon 1                |                                |

- 20** Panel Unit Fixation Screw
- 21** Mounting Bracket for Panel Unit
- 22** Audio Outputs
- 23** Connectors for Pedals
- 24** USB Connector

- 25** Power Supply Connector
- 26** Power Switch
- 27** Unit Connector Cable

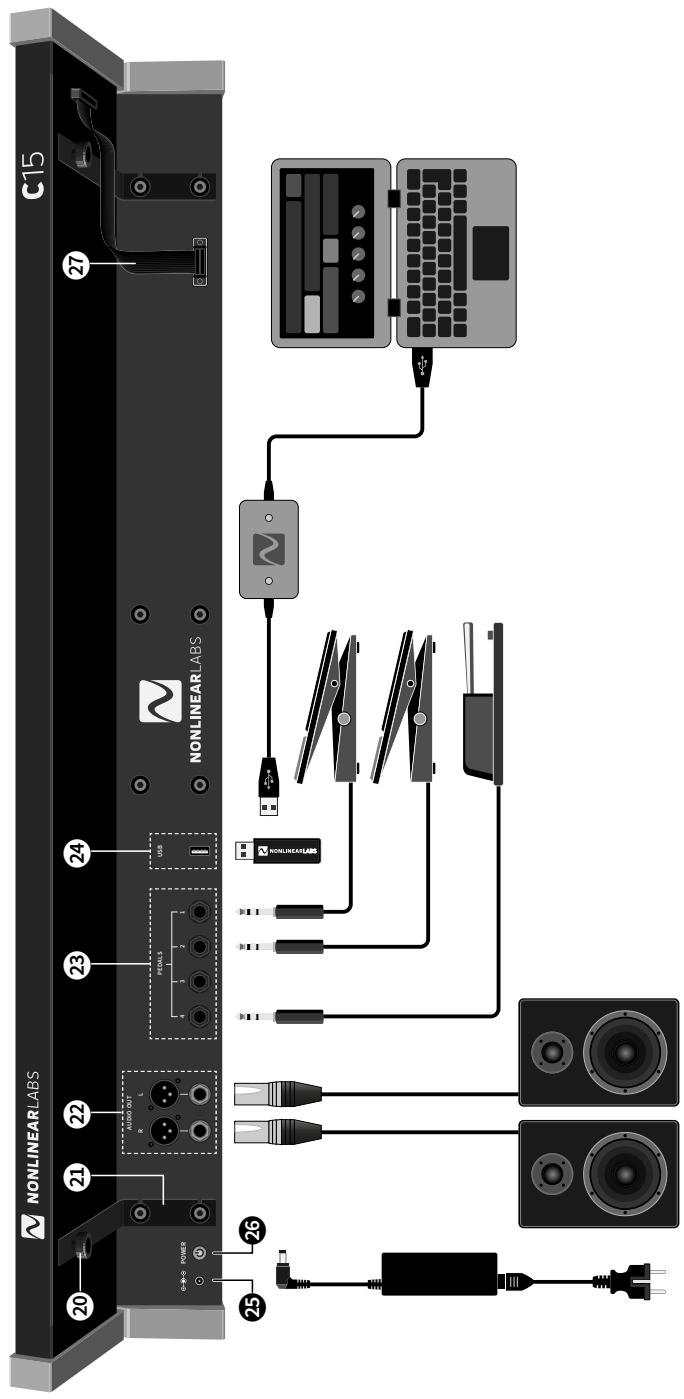
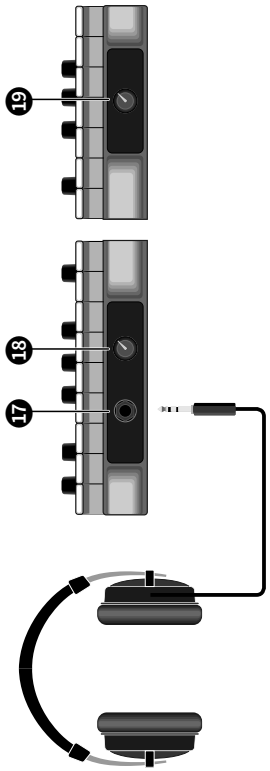

## Setting up the C15

### Mounting the Panel Unit

Ensure the C15 is switched off before following the next four steps:

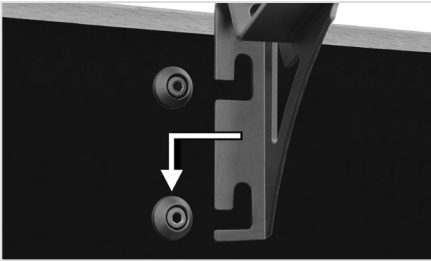

Attach the Mounting Brackets to the Base Unit by hooking and snapping them into place.



Place the Panel Unit onto the installed Mounting Brackets. The two Mounting Screws on the bottom of the Panel Unit fit into the holes at the top of each Mounting Bracket.



Tighten down the Mounting Screws to lock the Panel Unit into place.

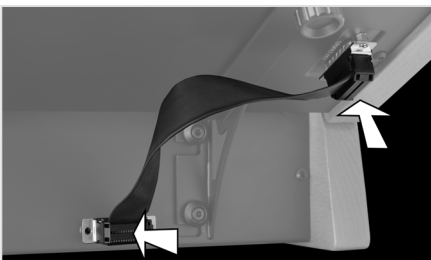

Connect Base Unit and Panel Unit with the Unit Connector Cable.

Now the C15 is ready to use and can be switched on. In order to disassemble the paired configuration, undo above four steps in reverse order. The C15's Base Unit can also be used without the Panel Unit.

## Connections

The following external connections are provided by the Base Unit:



The headphone output provides a 6.3 mm stereo headphone socket with separate, preset-independent adjustable headphone level. The headphone socket is suitable for all kinds of headphones but we strongly recommend to turn down the level when connecting low-impedance ear plugs.



The headphone level is independent from the main output level (see below).

The line output level is adjustable by the potentiometer at the right end of the front bar.



The audio output provides two parallel line-level stereo pairs of audio sockets (6.3mm TRS and XLR). Both pairs of sockets provide identical signals. The signals are transformer-balanced and ground-free, therefore in most cases a DI-box is not necessary. Unbalanced and balanced plugs can be connected. When connecting to unbalanced inputs please use unbalanced cables and plugs.

**!** Note that using both TRS and XLR outputs at the same time may cause hum.



Four 6.3 mm pedal sockets are provided for external pedal control. In general, any keyboard controller pedal can be connected. However, we recommend continuous pedals as they allow for the most nuanced performance.

# Connecting Pedals and mapping Hardware Sources

Most factory presets use a mapping as shown below. For more information on Hardware Sources and especially modulation aspects, refer to chapter 5.4 of the User Manual.

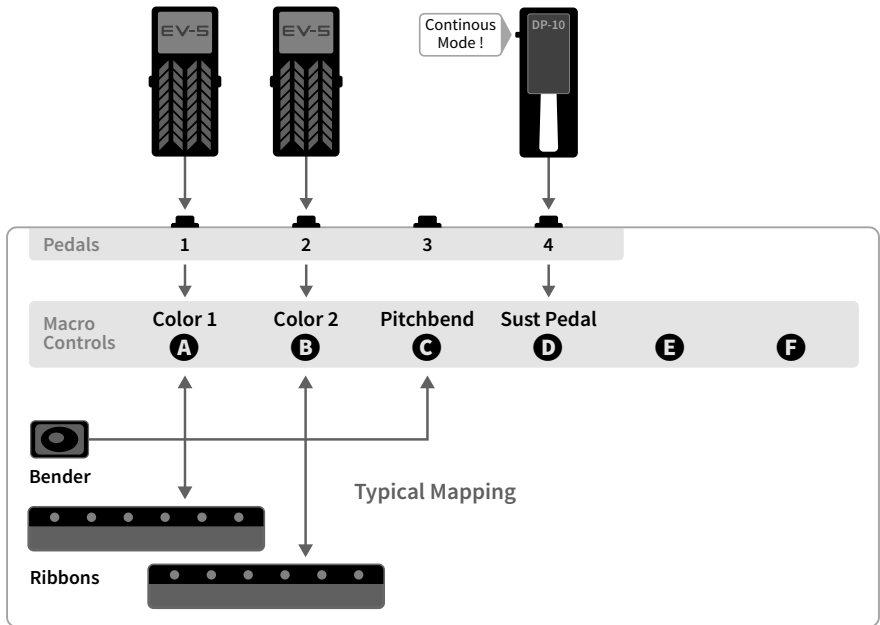





The USB connection is used for plugging in the USB flash drive included with the C15. The drive is used for transferring preset Banks and installing Updates.



The C15 comes with its own external power adapter, which connects to the power inlet. A small LED next to the inlet indicates the power, boot and shut-down status of the C15.

## Start and Shutdown



To turn on the C15, press the power button for around one second. It will take several seconds for the device to boot up and be ready to use. The most recent settings are loaded on startup. To shut down the C15, press the power button again for around a second. The shutdown process takes several seconds, during which it stores the current settings for the next startup, before the device turns off. A small LED next to the power inlet indicates the C15's status as follows:

steady lit	on/normal operation
slow blinking	booting
fast blinking	shutting down
flashing every 2 seconds	Standby mode

A flickering LED indicates an irregular operation mode. It means for example the supply voltage is too low.

**!** Make sure not to disconnect the power supply while you are using the C15 (booting up, performance, shutdown), otherwise its data may be lost.

# Setting up a Device for the Graphical User Interface

## Concept

The C15 is designed for flexible operation and interaction, with the Base Unit being necessary for connections and performance. In addition, the Panel Unit provides the Hardware User Interface, with access to all parameters, presets and settings.

Finally, the Base Unit also provides a Wi-Fi hotspot for connection to external devices like smartphones, tablets, laptops and desktop computers. When connected, the Graphical User Interface can be accessed with a browser running on the external device. Multiple external devices can be connected simultaneously, and each can display different features. However, only one parameter can be focussed on at a time, which synchronises the Hardware User Interface with each externally connected device.

Furthermore, the Wi-Fi connection can be used for preset interchange, and hence the option to back up preset banks to the external device. The C15 Reference is also accessible in the Graphical User Interface.

## System Requirements

Due to the browser-based implementation of the Graphical User Interface, there are almost no limitations concerning compatibility with operating systems and browsers. Basically, the only system requirements are that the device must be Wi-Fi capable and have a browser installed.

However, given the vast variety of devices, operating systems and browsers, optimal performance cannot be guaranteed in all cases. Differences between browsers, fast changes in technologies and frequent updates contribute to a complex situation which makes it very hard to say what works best.

Nevertheless, our experience in the development of the system enables us to make some recommendations and state some minimal requirements:

- The device should have at least a 1 GHz processor and 2 GB RAM.
- The device's display should support multi touch, or a mouse should be connected. A connected or integrated keyboard is useful for using the Graphical User Interface.
- The device should have at least a 7" diagonal display.
- Although the choice of browser is completely up to the user, currently (February 2022) the best performance is given by Google Chrome.

**i** *If you encounter problems with your setup, try to restart your device or change to another browser (or device). If not, or if the problem won't go away, please contact us directly for help. We appreciate feedback and user reports and will do our best to solve your problem as soon as possible.*

## Wi-Fi Settings

To set up a well defined Wi-Fi connection, enter the Setup Menu on the Hardware User Interface (Setup Button) and navigate to System Info. Here, all relevant aspects of the Wi-Fi connection are listed:

**Device Name** You can name your C15 instrument by focussing on the “Device Name” entry and pressing Enter to access the Rename Screen. Once the name is set, an SSID will be generated. The SSID is composed of a prefix (NL-C15-) and the name you just gave to the instrument.

**SSID** A Wi-Fi network with the same name as the SSID will be displayed when you scan for available networks on your external device. Changing the name of your C15 instrument will immediately generate a new SSID, meaning you will likely need to reconnect your external device to the C15 network.

**Passphrase** The network connection is secure, so a passphrase (WPA2 key) is needed to establish a connection. To connect to the network with your external device, use the displayed passphrase to confirm. The passphrase can be randomly generated or edited manually. To do this, please select the “Passphrase” entry, press Enter and select the appropriate command. If you suspect that the passphrase is no longer secure (because it has been shared with someone), a new passphrase should be generated.

**Website Address** **192.168.8.2**  
Once the connection is established, please enter this address into your browser's address bar and the Graphical User Interface should appear in your browser.

The Wi-Fi connection can also be disabled to provide a more secure setup and prevent anyone else controlling the device remotely. This may be especially useful when performing live. Enter the Setup Menu (Setup Button) and navigate to Device Settings. Find “Enable/Disable WiFi” entry and change the setting.

## Introduction to the User Interface

### Edit Panel

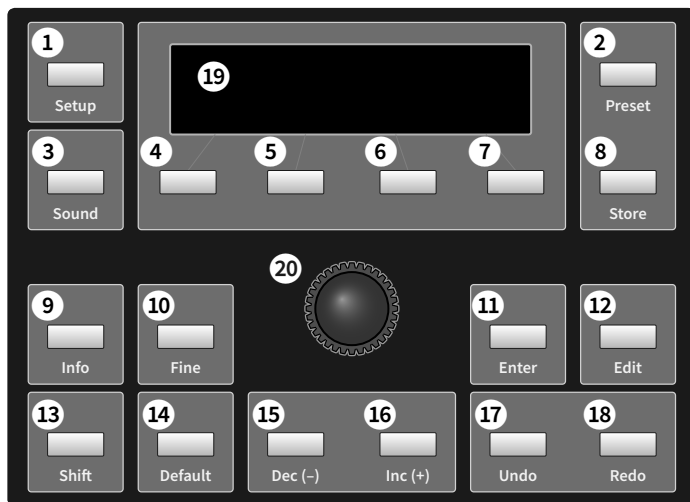

### Base Unit Control Panel



### Loading a Preset

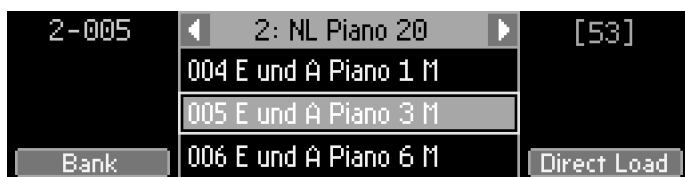

Open the Preset screen by pressing **Preset** **2**. Select a preset by the **Encoder** **20** or **Dec/Inc** **15** **16**.

When “Direct Load” is on, the preset will be loaded instantly, otherwise **Enter** **12** will load the preset. Toggle “Direct Load” mode by pressing **Soft Button** **7**. Other preset banks can be selected by the two **Soft Buttons** **5** **6**. Pressing the “Bank” **Soft Button** **4** redirects to the Preset screen in Bank mode, where banks can be selected by the **Encoder** **20** or **Dec/Inc** **15** **16**, and presets can be selected by the **Soft Buttons** **5** **6**.

## Storing a Preset

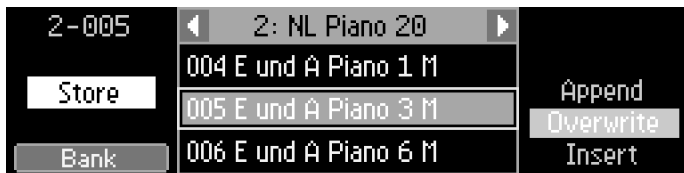

Pressing **Store** **8** opens the Preset screen in Store mode.

With the **Soft Button** **7** you can choose “Append”, “Overwrite” or “Insert”, creating a new preset at the end of the list (append), behind the selected preset (insert), or overwriting the data of the selected preset (overwrite).

The store location can be changed by the **Encoder** **20** or **Dec/Inc** **15** **16**. Other preset banks can be selected by the two **Soft Buttons** **5** **6**.

To finish the store process press **Enter** **11**. Pressing **Store** **8** will cancel the process. When storing a new preset the Rename screen will open, so you can edit the label.

## Edit

Certain elements include additional functions which will be provided when pressing **Edit** **12**. Examples of additional functions are “Rename”, “Edit Info” (for presets, banks and Macro Controls) as well as “Copy”, “Paste”, or “Delete” (for presets and banks).

## Init Sound

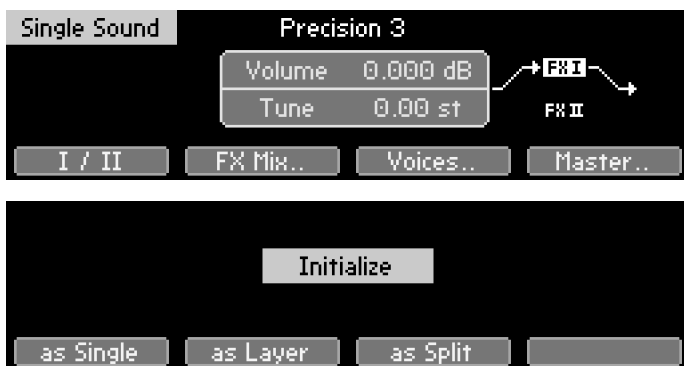

Pressing **Sound** **3** will invoke the Sound screen, providing options to further manipulate the current sound. Press and hold **Default** **14** to open the Init Screen and then press either **Soft Button** **4** **5** or **6** to recall the Init sound as Single, Layer or Split. Every parameter will load its default value.

**i** Note that the factory default values for Output Mixer component levels are zero, meaning that the initial sound is silent.

## Adjusting a Parameter

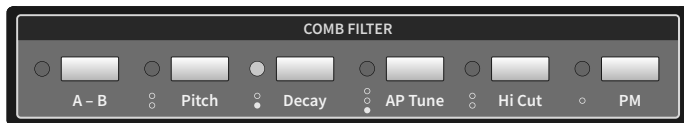

The parameters of the synth engine can be accessed by the 96 selection buttons. The LED of the pressed button will light up. Dots below the LED indicate if additional parameters can be selected by pressing the button multiple times. The stack of selectable parameters is also shown at the right side of the **display 19**. You can step through it by using the **Soft Button 7** as well.

The selected parameter can be adjusted by the **Encoder 20** and **Dec/Inc 15 16**. Pressing **Default 14** recalls the default value. The resolution can be toggled between coarse and fine mode by pressing **Fine 10**.

## Macro Controls



Up to six Macro Controls (MC) can be assigned to modify the sound of a preset. You can access them by their **Selection Buttons A B C D E F**. Their labels and info can be defined per preset. For the selected MC the LEDs of the target parameters will blink. The MC can be adjusted like a parameter. It can be influenced by Hardware Sources as well, as shown by the ten small bar graphs at the right end of the **display 19**.

## Assigning a Macro Control to a Hardware Source

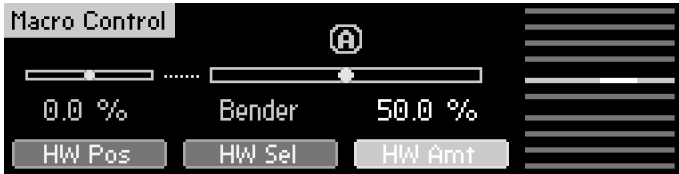

Macro Controls can follow movements of multiple Hardware Sources. There are ten Hardware Sources provided by the C15: four connectors for external pedals, two Ribbons (plus two virtual Ribbons), the Bender and monophonic Aftertouch. In order to assign a Hardware Source to a selected Macro Control, use the “HW Sel” **Soft Button 5** and select the desired Hardware Source by using the **Encoder 20** or **Dec/Inc 15 16**. The **Soft Button 7** can also be used to select a Hardware Source. For the selected Hardware Source use the “HW Amt” **Soft Button 6** to adjust its influence on the MC.

## Assigning a Parameter to a Macro Control



The most significant parameters can follow movements of a Macro Control. In order to assign the selected parameter to a Macro Control, use the “MC Sel” **Soft Button 5** and select the desired Macro Control by using the **Encoder 20** or **Dec/Inc 15 16**. When a Macro Control has been chosen, use the “MC Amt” **Soft Button 6** to focus on the modulation amount and adjust the amount like a parameter. The modulation amount of a parameter specifies intensity and direction of its movement, following the assigned Macro Control.

## Info

Press **Info 9** to get information about a parameter, Macro Control, preset or bank. The infos of Macro Controls, presets and banks are user-definable.

## Undo / Redo

For un-doing and re-doing editing steps use **Undo/Redo 17 18**. Pressing both of them at the same time will open the undo history in the **display 19**.

## Base Unit Functionality

The Base Unit provides four operational modes which can be selected with **Mode** 24. In Play mode, the **display** 25 shows the labels of the Macro Controls to which the Ribbons are assigned (or “not assigned”).

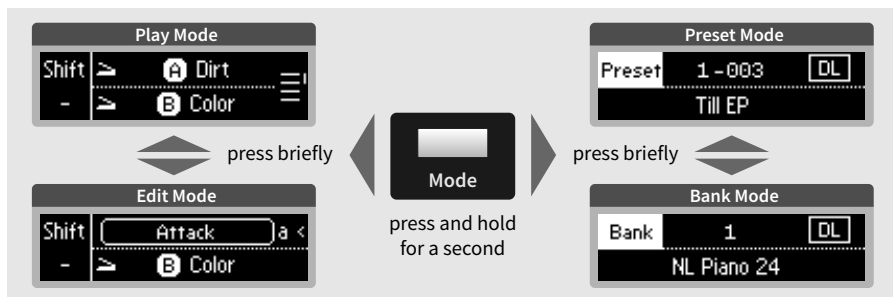

The two physical Ribbons can be used for up to four virtual Ribbons. On the right edge, the four horizontal lines and the right vertical indicator show which two of the four virtual ribbons are selected.

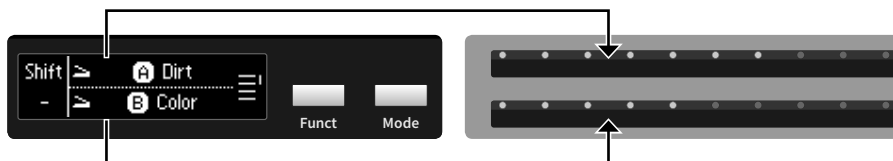

You can select between the Ribbon pairs by pressing **Funcnt** 23. Depending on which ribbon pair is selected, the two physical ribbons are assigned to either Ribbon 1 & 2 or Ribbon 3 & 4. Pressing and holding **Funcnt** 23 for at least one second, Play Mode will change from the Ribbon Select view to Touch Behaviour view. The letter “a” or “r” indicates if the touch strip works as an absolute or relative input device. The last touched Ribbon is indicated by “<” and its input mode can be switched with **Funcnt** 23.

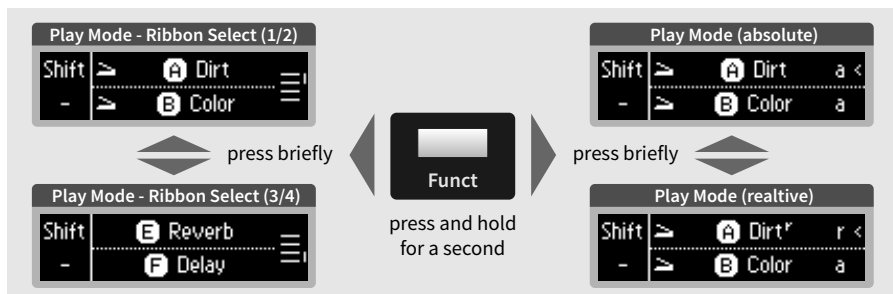



With **-/+ 21 22** you can shift the keyboard range up and down by octaves. Holding one button while pressing the second will shift the pitch by semitones.



In **Edit mode**, Ribbon 1 will be assigned to the currently selected parameter as additional editing tool, while Ribbon 2 remains in play mode.

In **Bank mode**, banks can be navigated with **-/+ 21 22**, while **Funct 23** serves as “Direct Load” (DL) switch when held for a second.

In **Preset mode**, presets can be navigated with **-/+ 21 22**. When “Direct Load” is off and an arrow is shown, **Funct 23** will load/reload the selected preset. “Direct Load” (DL) can be toggled by holding **Funct 23** for a second.

**!** *Please save your preset banks before installing the update!*

The most convenient way is to use the menu entry “Save all Banks as Backup File..” in the graphical user interface or with “Backup” and “Save all Banks..” in the Setup menu in the Panel Unit display.

**!** *Do not power off the C15 during the update installation! An interruption of the power in this phase can cause irreversible damage.*

### Steps to proceed:

1. The latest installer is offered on:  
[www.nonlinear-labs.de/support/updates/updates.html](http://www.nonlinear-labs.de/support/updates/updates.html)
2. By clicking its button you download the file “nonlinear-c15-update.tar” to your computer. You will also find a PDF file “Whats New?” on the website to inform you about the latest feature updates and bug fixes.
3. Your computer might offer to unpack this type of file. Please make sure that the file is NOT unpacked or changed in any way.
4. Copy the file (“nonlinear-c15-update.tar”) to the root folder of the USB memory stick that was delivered with the C15. (Other memory sticks will only work if they have the FAT32 format.)
5. Switch off the C15 and plug the memory stick into the USB connector at the backside of the C15.
6. Switch on the C15. During the update process the small display will show “Updating..” messages.
7. When the update is finished, the display will show: “Updating C15 DONE! Please restart!” Please switch off the instrument, remove the memory stick and switch it on again.

**!** *If you update from version 21-02 you might get the error message “Updating C15 FAILED” during the installation. In this case the installer needs to be run a second time. Please restart the C15 without removing the USB stick. Now the update should be successful.*

**i** *After a successful update the file on the memory stick is automatically renamed to “nonlinear-c15- update.tar-copied”. Please delete this file before using the stick for another update.*

*All downloaded update files have identical names (“nonlinear-c15-update.tar”). This is the file name required by the C15 to detect an update on the memory stick. If there is an earlier update file with this name in the download folder of your browser, the name of the new update will be modified (e.g. by adding “-1”). Therefore please check if the file has been renamed and restore the original name. It is recommended to remove all C15 update files from the download folder.*

*If you want to store different updates on your computer, please keep them in separate folders or rename them, so that you can identify them later.*

*You can check the current software versions in the “System Info” section of the Setup. For this press the “Setup” button on the Edit Panel or the “Setup” entry in the view menu of the graphical user interface and select “System Info”. Here you find the “Software Version”. It shows the release date as year and week in the format YY-WW (e.g. 20-40 - week 40 in year 2020).*

*If a “FAILED” message appears in the display, the update was not successful. In this case please repeat the installation. Rename the installer file to the original name “nonlinear-c15-update.tar”, plug in the USB stick and start the C15 again. If this is without success please contact us. On the USB stick you will find a log file (“nonlinear-c15-update.log.txt”) which you can send us to help us analyzing the problem.*

# C15 Synth Engine - Signal Flow

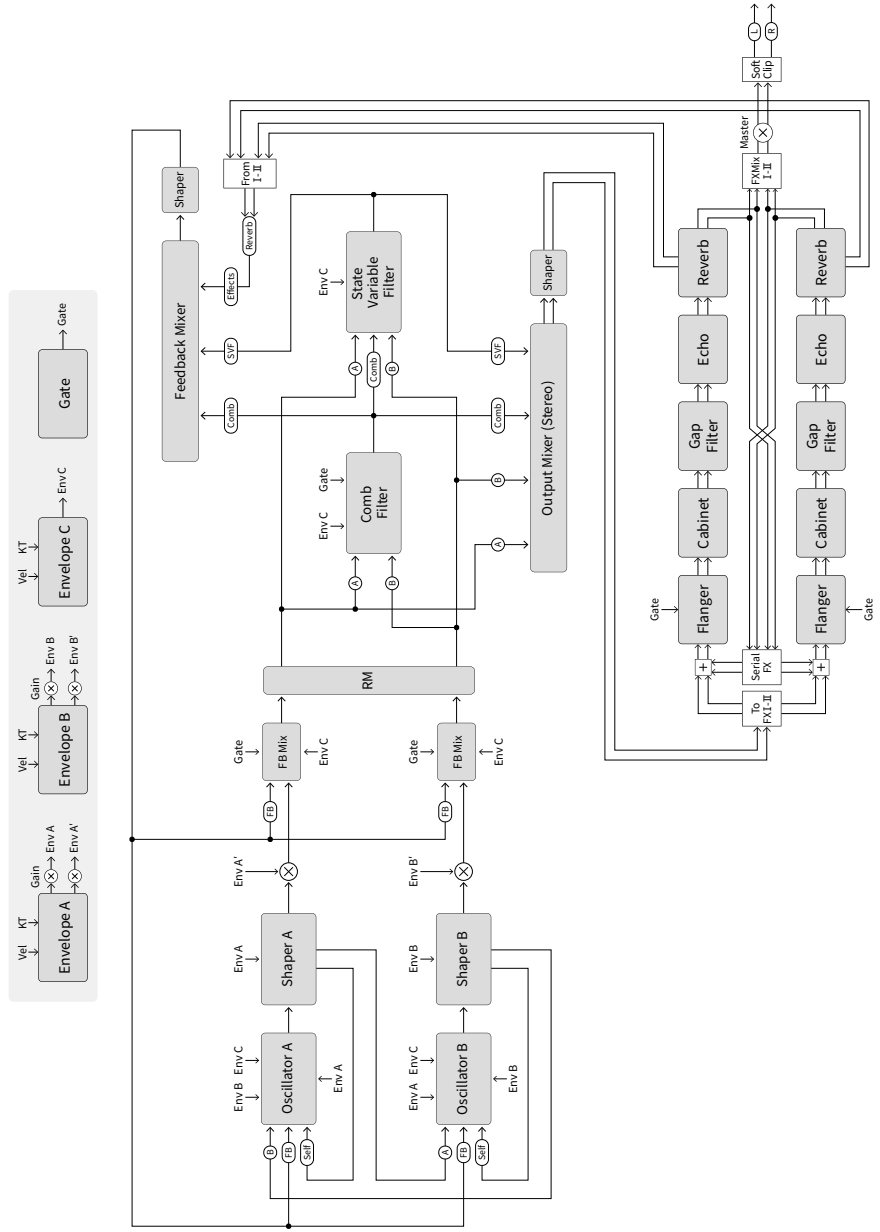

# C15 Synth Engine – Signal Flow Detailed

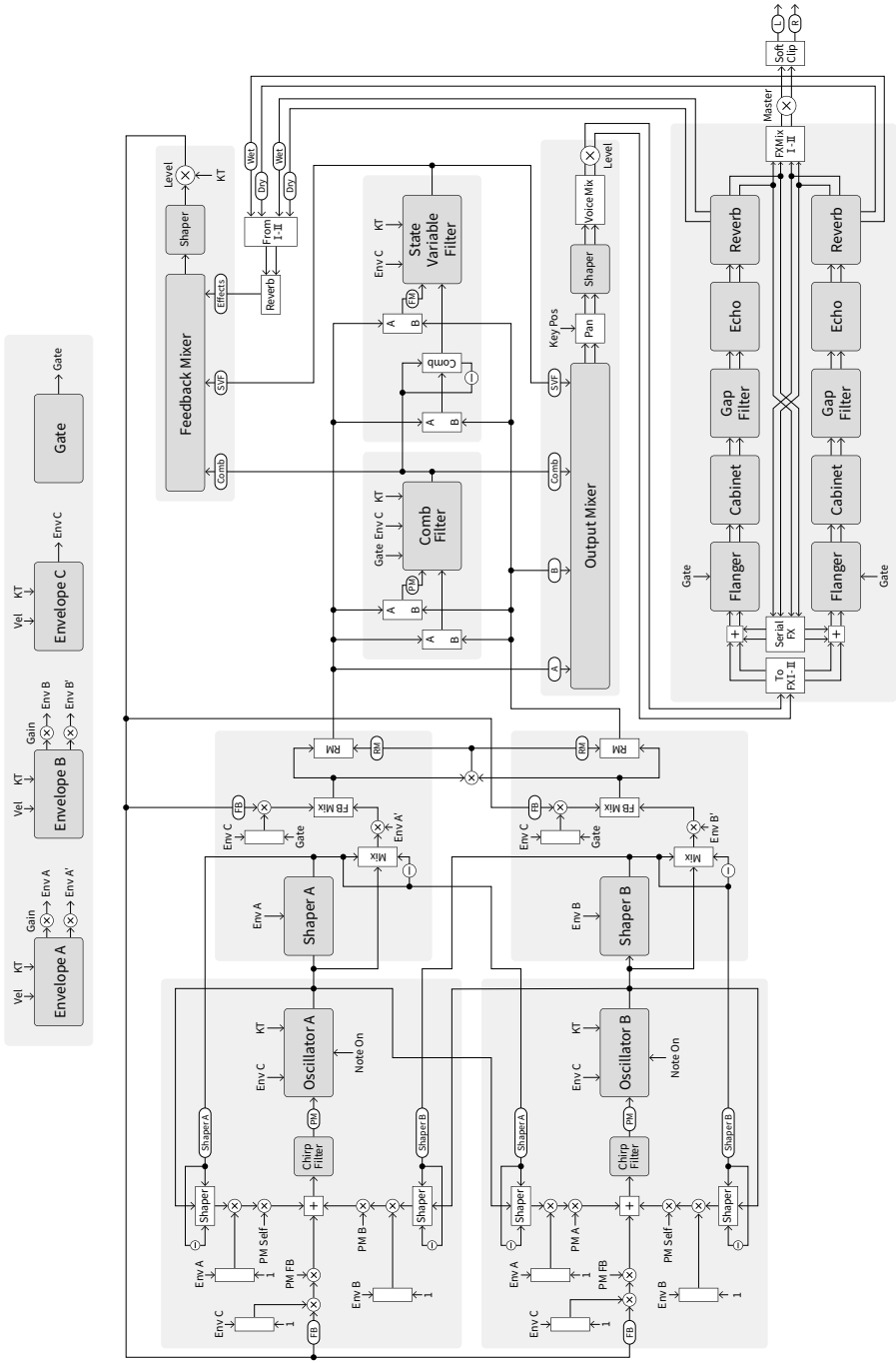

# C15 Synth Engine – Single Sound Overview

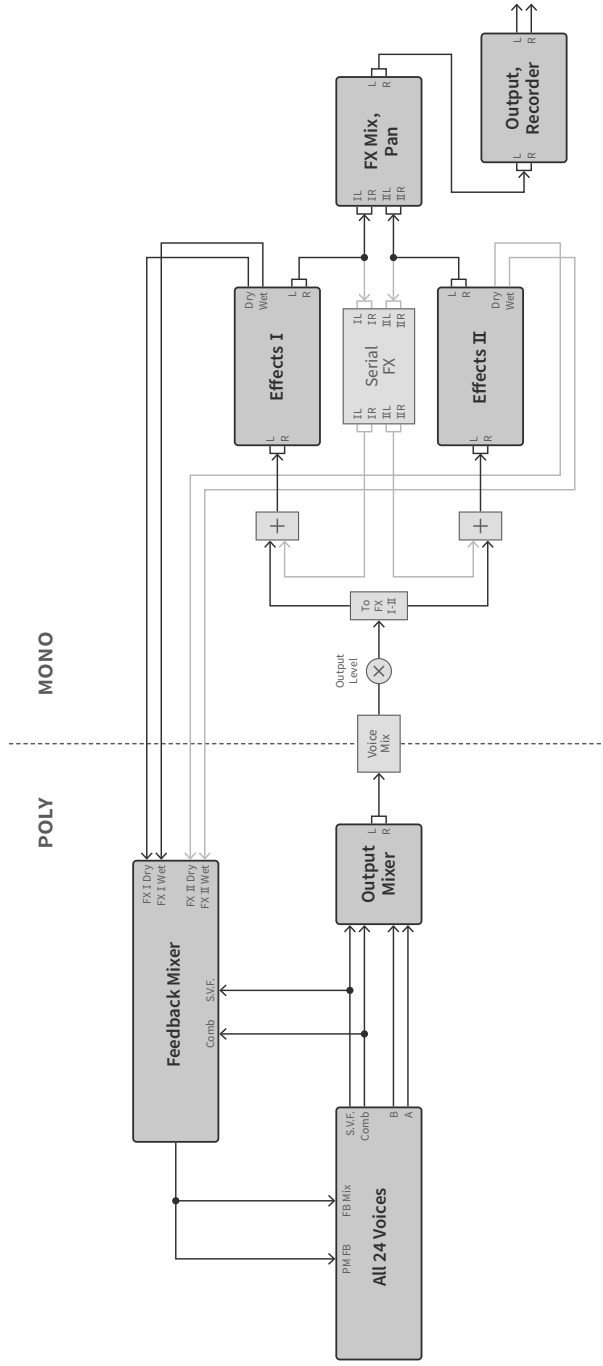

# C15 Synth Engine - Layer/Split Sound Overview

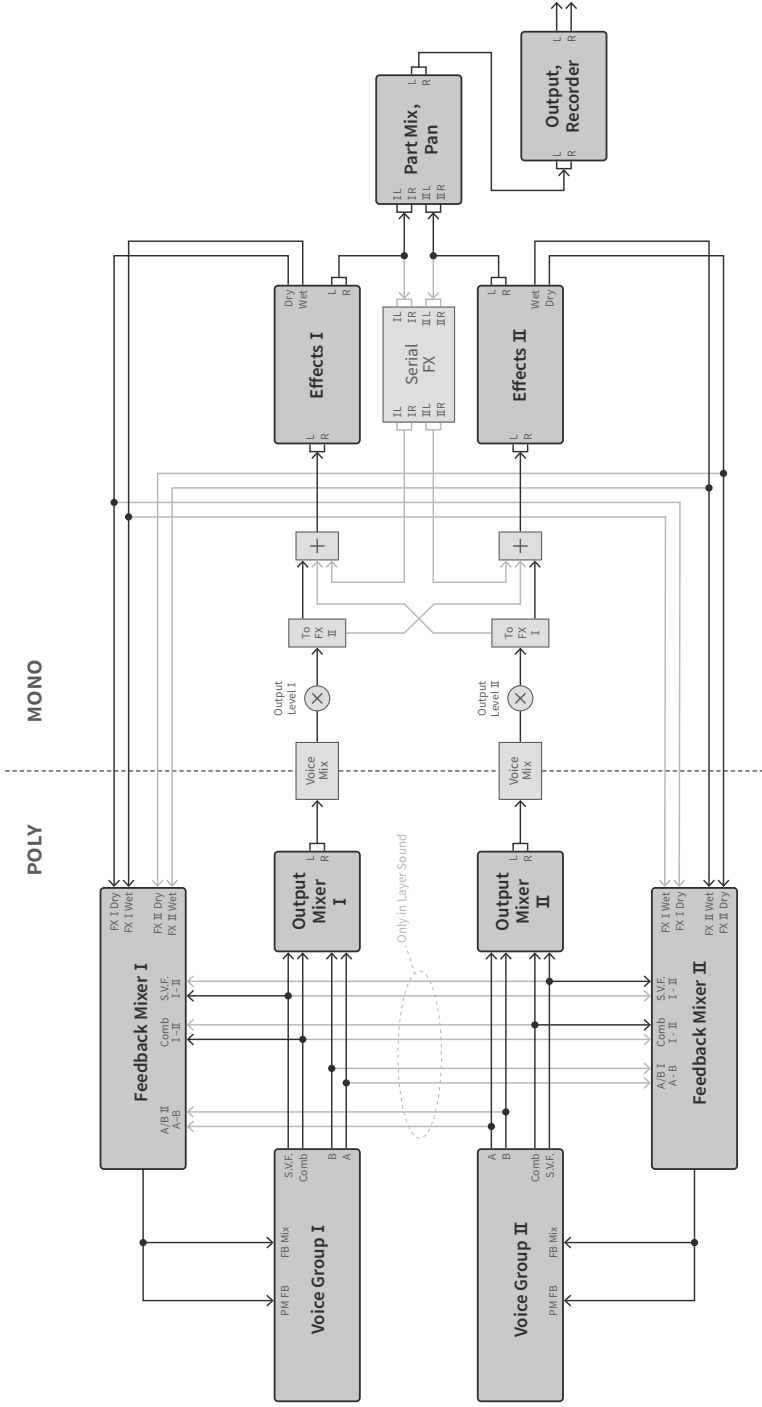



# **NONLINEARLABS**

NONLINEAR LABS GmbH  
Helmholtzstraße 2-9 E  
10587 Berlin  
Germany

[www.nonlinear-labs.de](http://www.nonlinear-labs.de)  
[info@nonlinear-labs.de](mailto:info@nonlinear-labs.de)

Quickstart Manual  
Document Version: 4.5  
Date: Oct 10, 2023

© NONLINEAR LABS GmbH, 2023, All rights reserved.